

Specification

1. Product Type: Panel Antenna
2. Frequency: 600~6000 MHz
3. VSWR: MIN 1.3:1
4. Bandwidth: $\leq 360\text{MHz}$
5. Connector: N F

✧RoHS Compliant

ROHS

150 9001

150 14001

Material:		Treatment:					
NO	DESCRIPTION	MATERIAL	FINISH	Q'TY	Unit: mm		TITLE
Part NO					Ver: A	Scale 1:5	Model NO
					File NO: QR0402	Drawing NO	PANEL-002.dft

Frequency (MHz)	Return Loss (dB)	VSWR	Efficiency (%)	GAIN (dB)
600	-5.11	3.50	37.84	2.82
650	-5.79	3.09	43.55	3.84
690	-5.93	3.02	61.38	5.66
700	-7.10	2.61	52.48	5.23
800	-12.83	1.61	85.11	8.21
824	-21.88	1.17	90.57	8.58
868	-25.42	1.11	93.11	9.09
915	-16.64	1.33	85.51	8.86
960	-16.78	1.34	93.54	9.62
1710	-10.93	1.79	62.66	6.8
1800	-14.38	1.47	86.5	8.32
1880	-13.43	1.55	75.16	8.17
2170	-17.06	1.33	88.1	8.53
2300	-23.86	1.14	70.31	6.91
2400	-22.83	1.15	78.16	6.97
2500	-24.16	1.13	89.33	8.64
2600	-22.95	1.15	76.74	9.28
2700	-20.82	1.19	83.18	10.02
3300	-19.83	1.22	98.63	9.47
3400	-33.06	1.05	94.41	8.97
3600	-22.16	1.16	91.62	8.77
3800	-25.48	1.11	91.83	9.52
4400	-17.57	1.31	55.46	8.97
5100	-13.82	1.51	65.77	9.38

5500	-17.13	1.40	51.88	7.41
5800	-15.35	1.49	55.59	5.18
5950	-18.27	1.29	68.87	5.85

Test Data (Return Loss & VSWR)

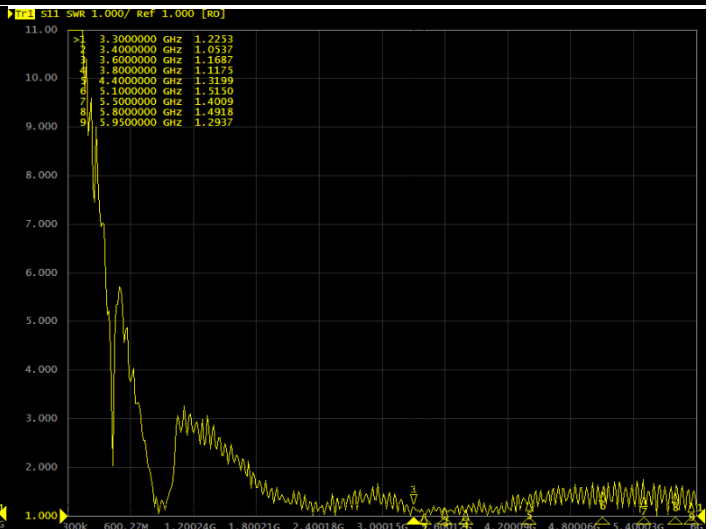
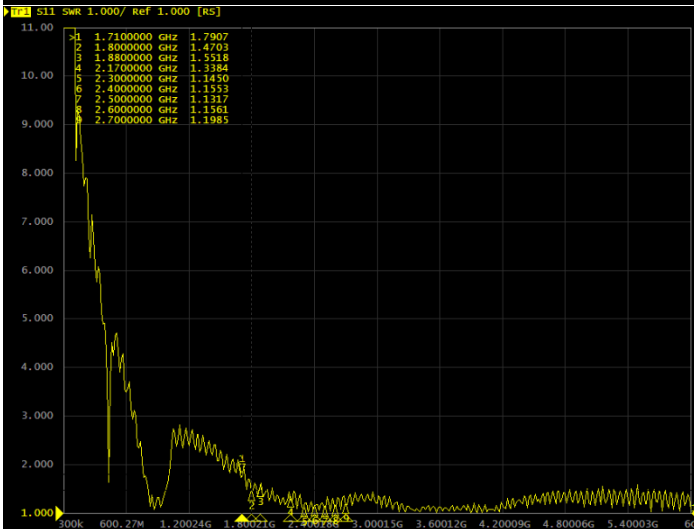
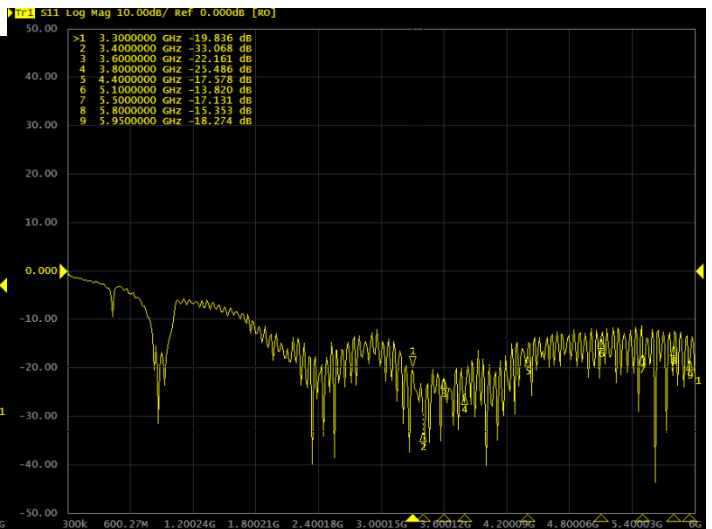
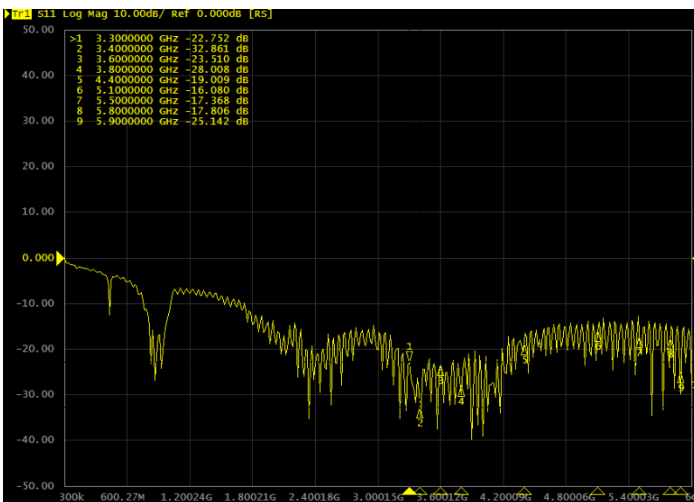
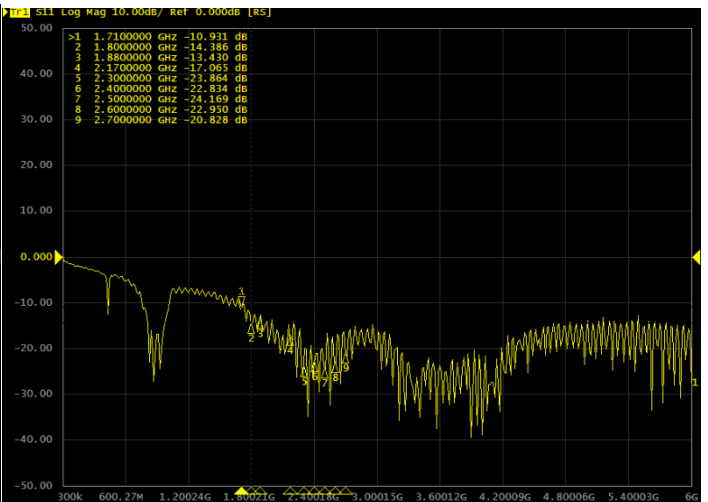
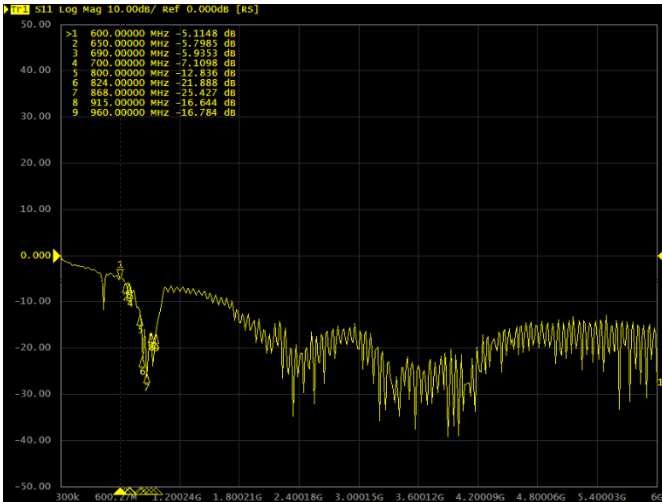

3D Test Photo

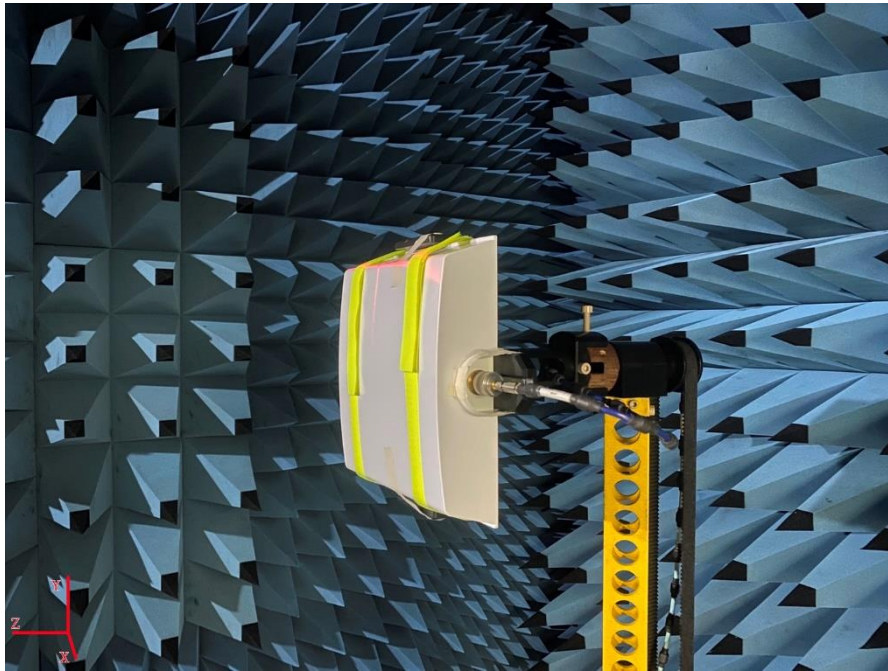

3D Test Data

Freq. / Chan.	Color
600MHz	Red
650MHz	Blue
690MHz	Green
700MHz	Magenta
800MHz	Cyan
824MHz	Yellow
868MHz	Black
915MHz	Purple
960MHz	Dark Blue
1.71GHz	Teal
1.8GHz	Orange
1.88GHz	Light Blue
1.99GHz	Dark Green
2.17GHz	Pink
2.3GHz	Light Orange
2.4GHz	Brown
2.6GHz	Dark Blue
2.7GHz	Grey
3.3GHz	Olive Green
3.4GHz	Brown
3.6GHz	Black
3.8GHz	Red
4.4GHz	Blue
5.1GHz	Green
5.5GHz	Magenta
5.8GHz	Cyan
5.95GHz	Yellow

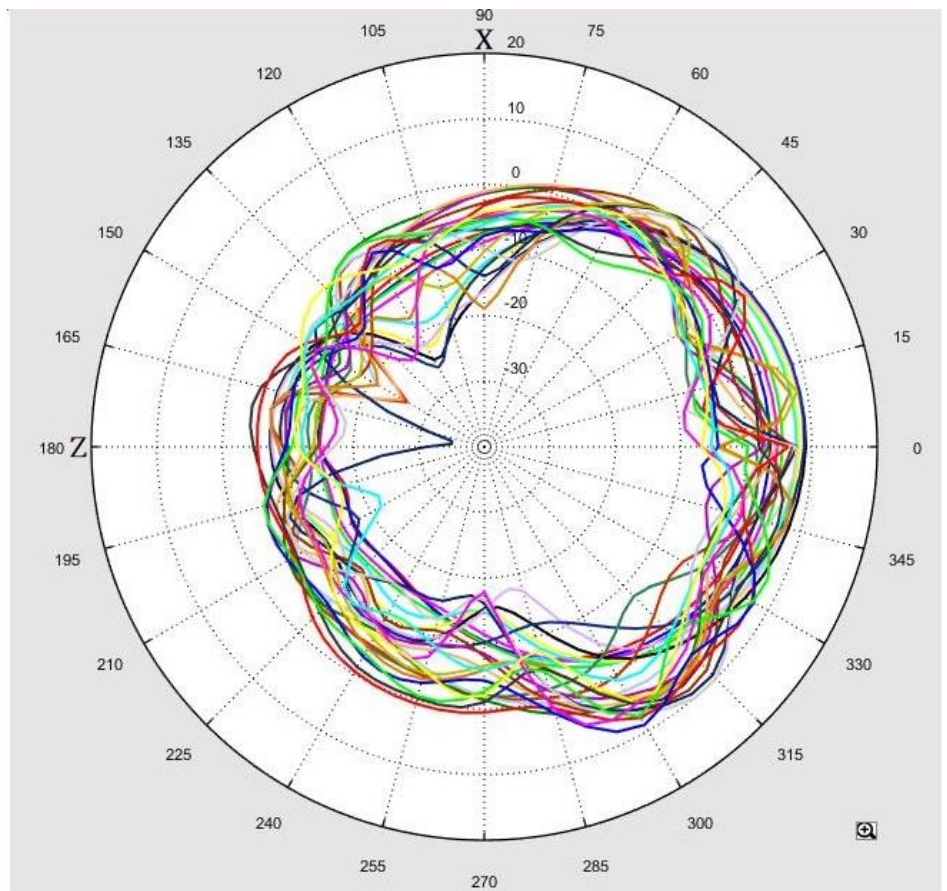

Total_Efficiency (%)

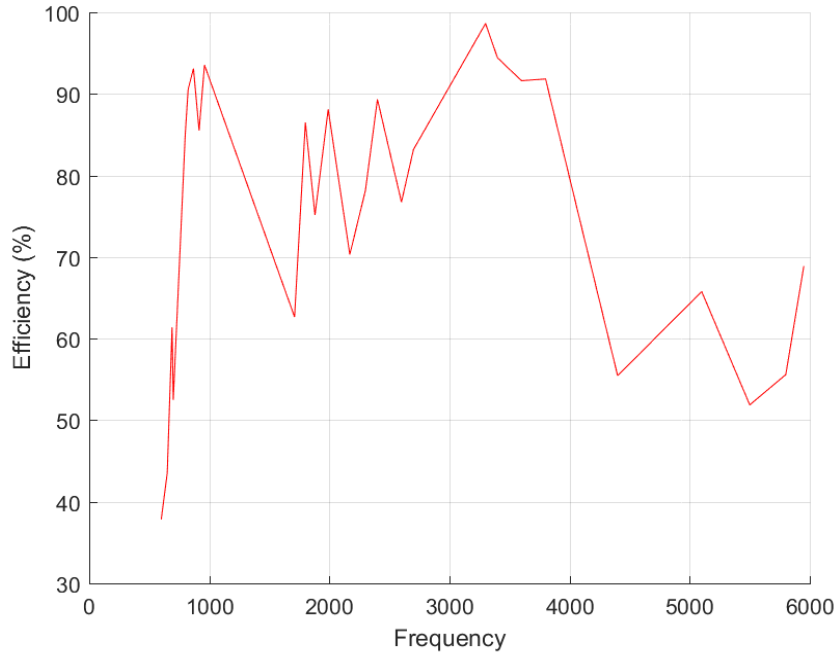

Total_Gain (dBi)

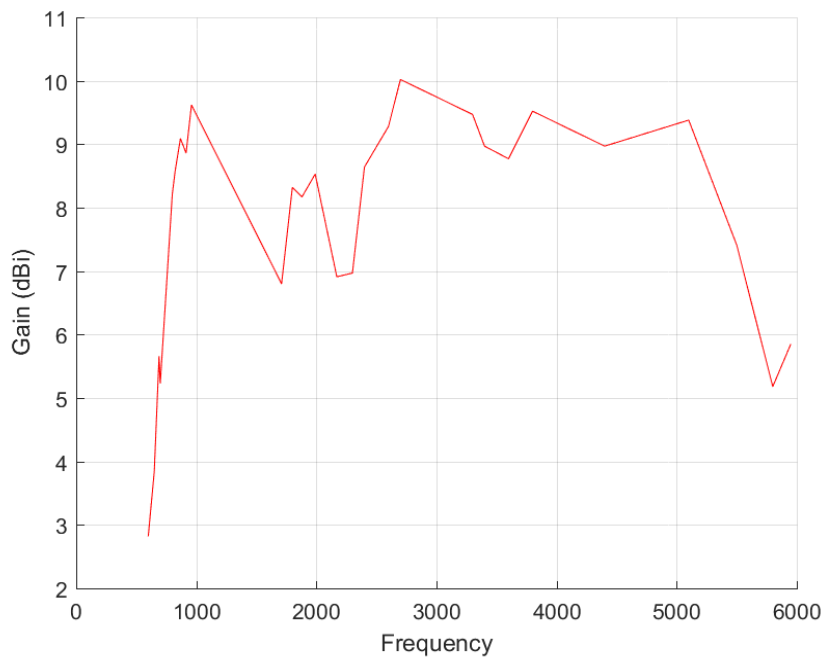

Total_3D_Top View_600MHz

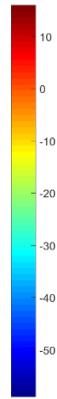
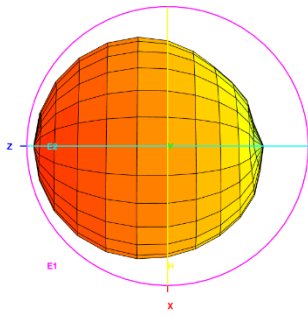

Total_3D_Front View_600MHz

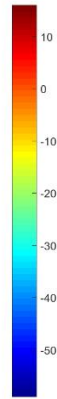
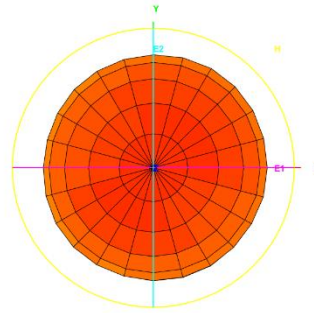

Total_3D_Left View_600MHz

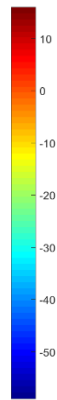
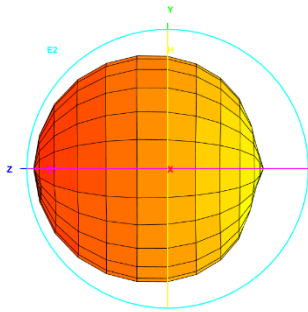

Total_3D_Side View 1_600MHz

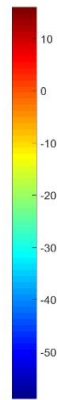
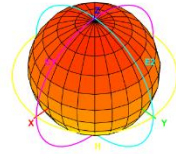

Total_3D_Top View_650MHz

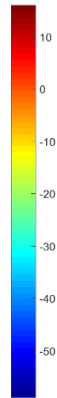
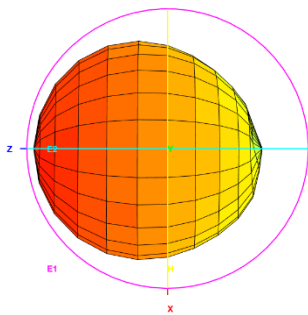

Total_3D_Front View_650MHz

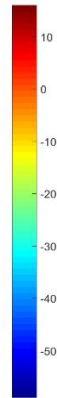
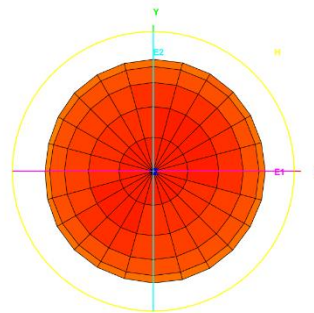

Total_3D_Left View_650MHz

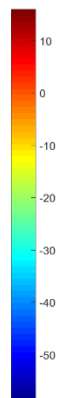
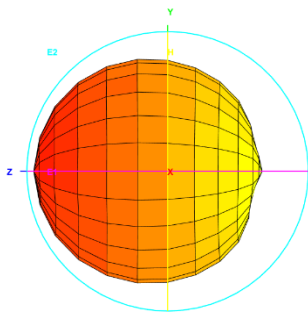

Total_3D_Side View 1_650MHz

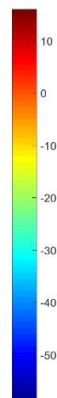
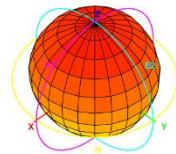

Total_3D_Top View_690MHz

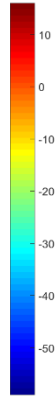
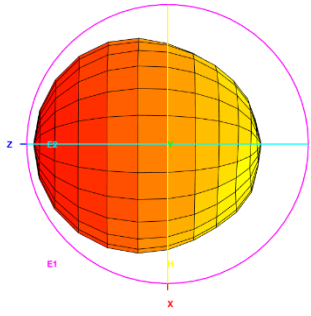

Total_3D_Front View_690MHz

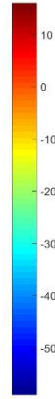
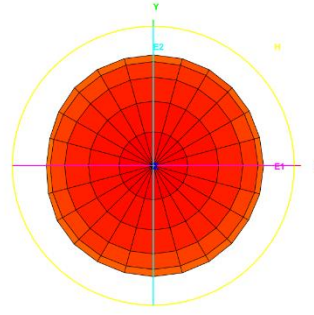

Total_3D_Left View_690MHz

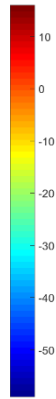
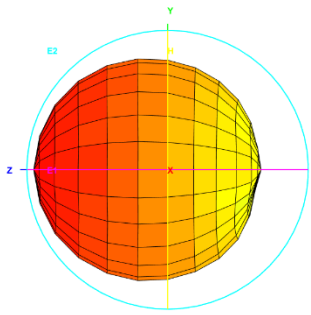

Total_3D_Side View 1_690MHz

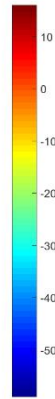
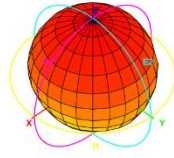

Total_3D_Top View_700MHz

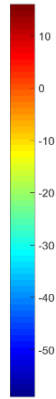
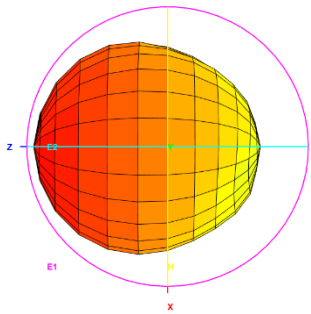

Total_3D_Front View_700MHz

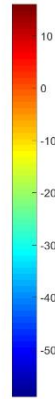
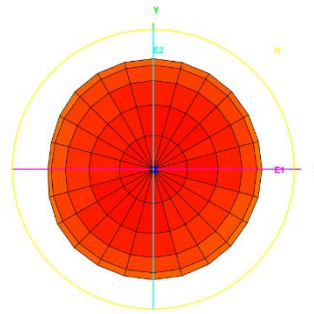

Total_3D_Left View_700MHz

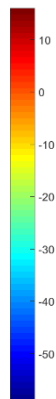
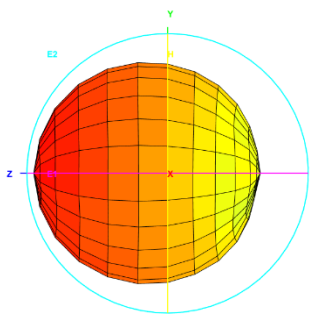

Total_3D_Side View 1_700MHz

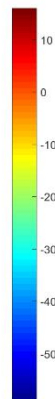
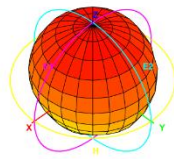

Total_3D_Top View_800MHz

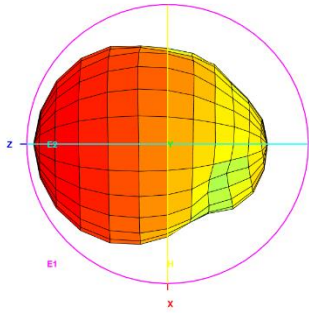

Total_3D_Front View_800MHz

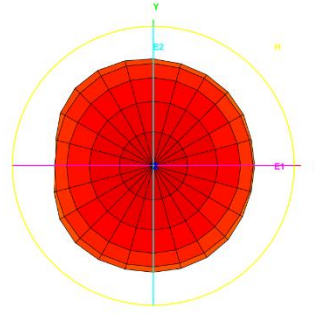

Total_3D_Left View_800MHz

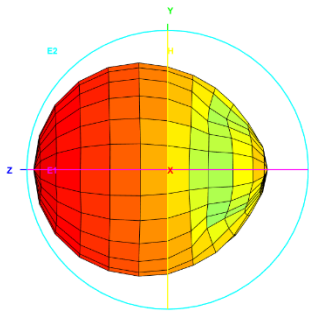

Total_3D_Side View 1_800MHz

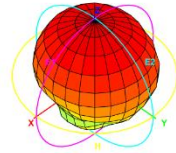

Total_3D_Top View_824MHz

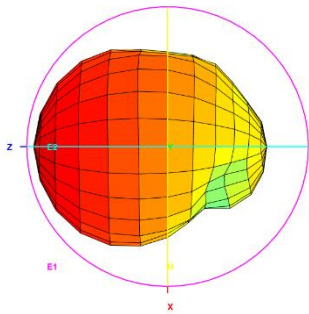

Total_3D_Front View_824MHz

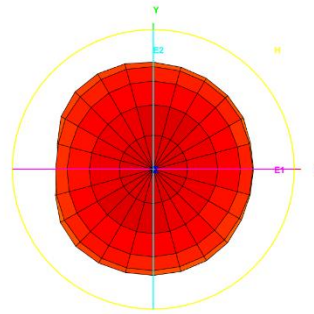

Total_3D_Left View_824MHz

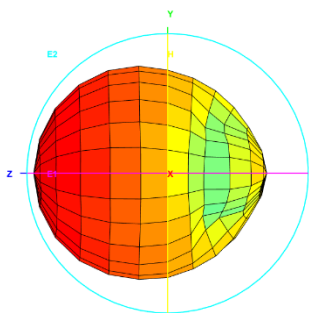

Total_3D_Side View 1_824MHz

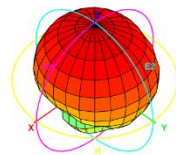

Total_3D_Top View_868MHz

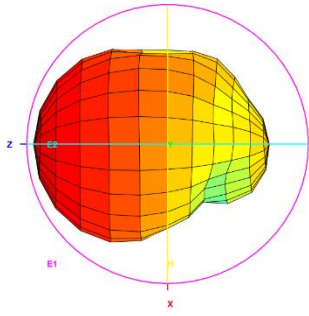

Total_3D_Front View_868MHz

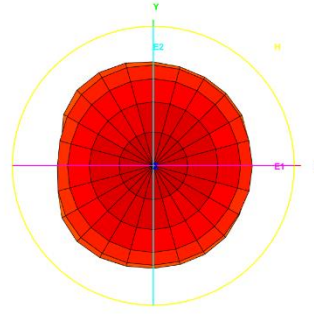

Total_3D_Left View_868MHz

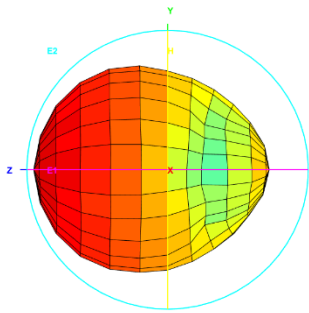

Total_3D_Side View 1_868MHz

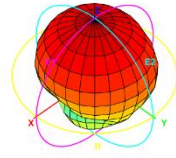

Total_3D_Top View_915MHz

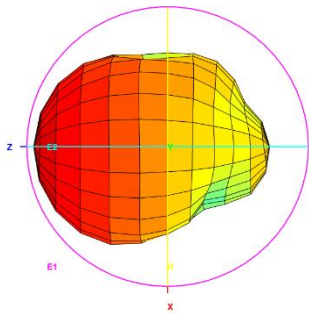

Total_3D_Front View_915MHz

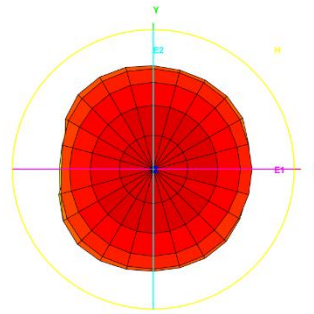

Total_3D_Left View_915MHz

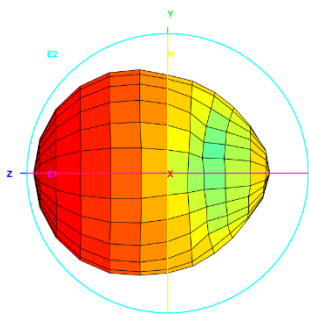

Total_3D_Side View 1_915MHz

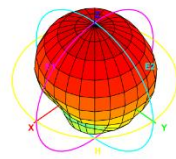

Total_3D_Top View_960MHz

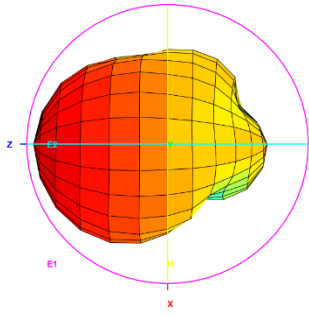

Total_3D_Front View_960MHz

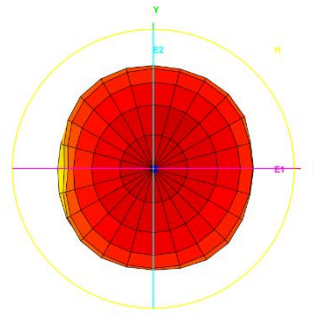

Total_3D_Left View_960MHz

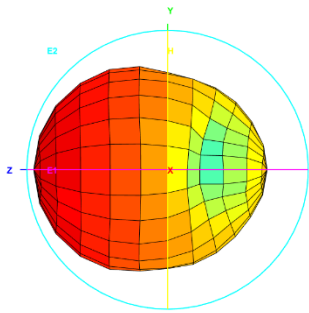

Total_3D_Side View_1_960MHz

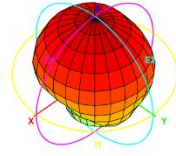

Total_3D_Top View_1.71GHz

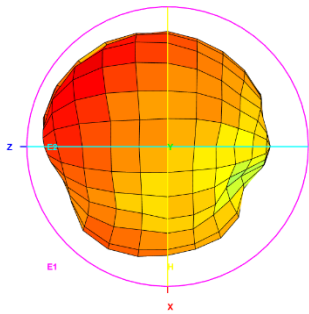

Total_3D_Front View_1.71GHz

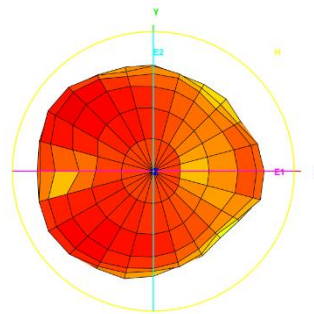

Total_3D_Left View_1.71GHz

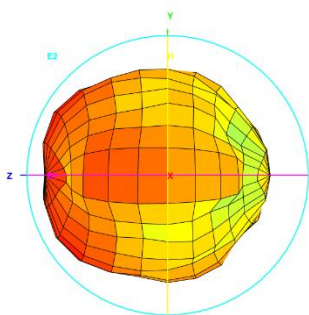

Total_3D_Side View_1_1.71GHz

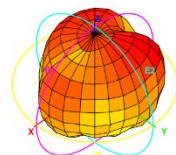

Total_3D_Top View_1.8GHz

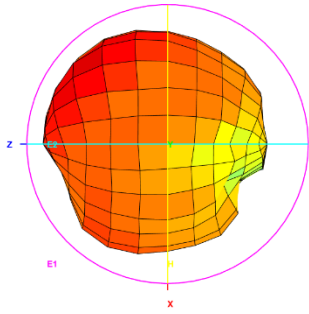

Total_3D_Front View_1.8GHz

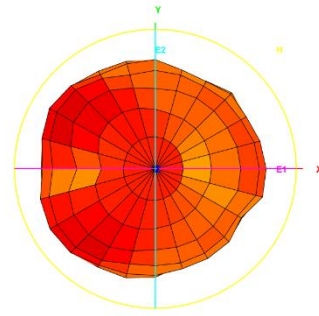

Total_3D_Left View_1.8GHz

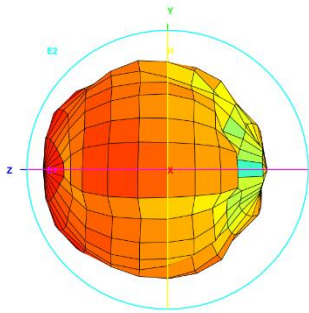

Total_3D_Side View_1.8GHz

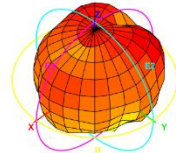

Total_3D_Top View_1.88GHz

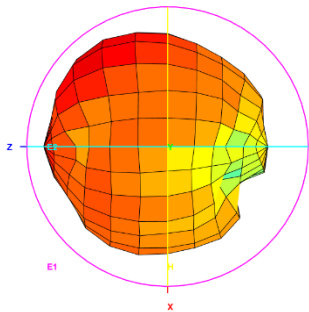

Total_3D_Front View_1.88GHz

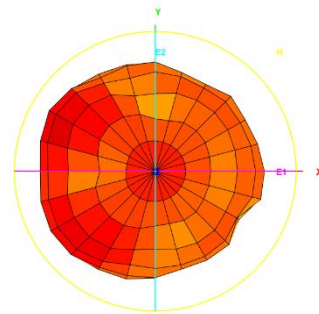

Total_3D_Left View_1.88GHz

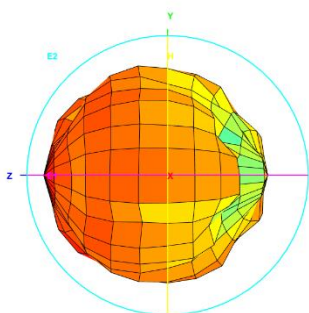

Total_3D_Side View_1.88GHz

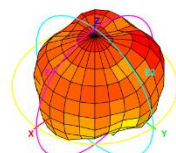

Total_3D_Top View_1.99GHz

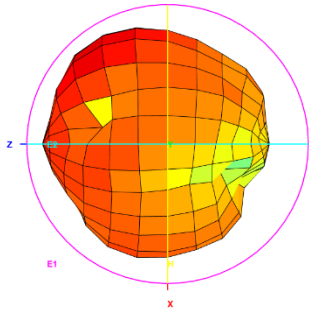

Total_3D_Front View_1.99GHz

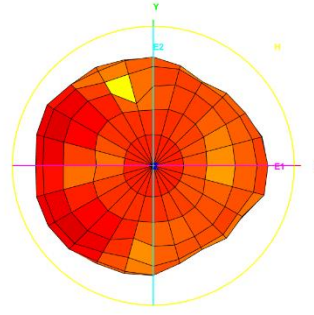

Total_3D_Left View_1.99GHz

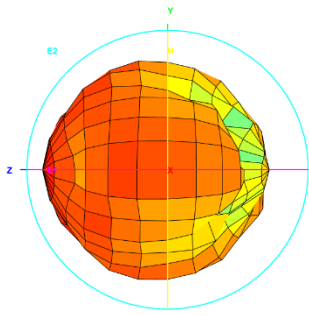

Total_3D_Side View 1_1.99GHz

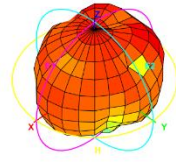

Total_3D_Top View_2.17GHz

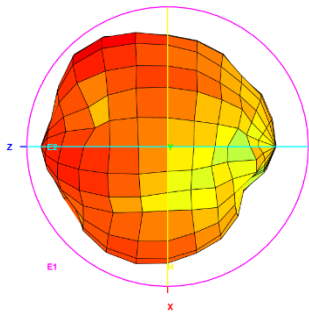

Total_3D_Front View_2.17GHz

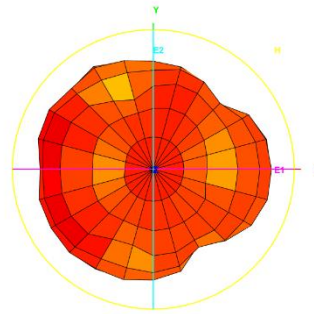

Total_3D_Left View_2.17GHz

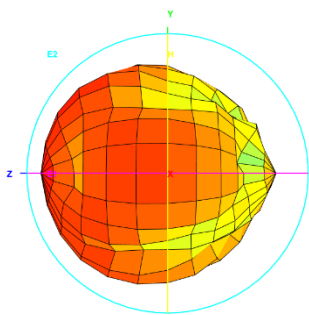

Total_3D_Side View 1_2.17GHz

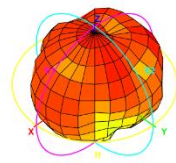

Total_3D_Top View_2.3GHz

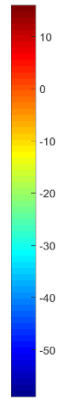
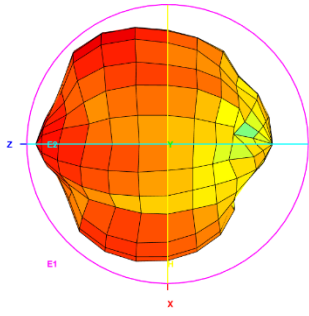

Total_3D_Front View_2.3GHz

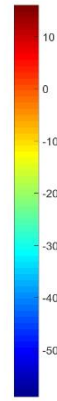
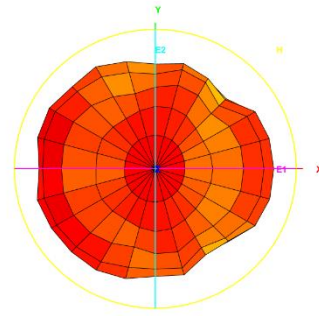

Total_3D_Left View_2.3GHz

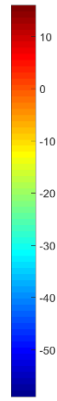
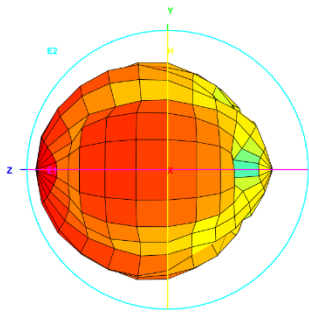

Total_3D_Side View 1_2.3GHz

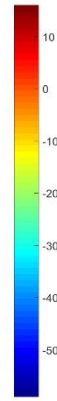
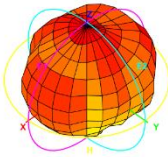

Total_3D_Top View_2.4GHz

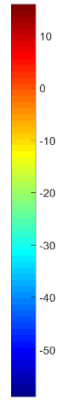
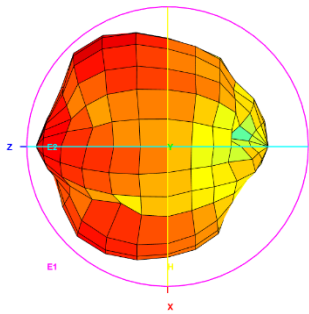

Total_3D_Front View_2.4GHz

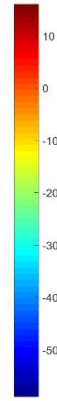
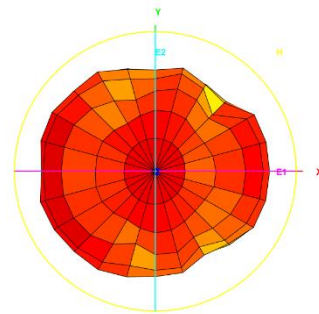

Total_3D_Left View_2.4GHz

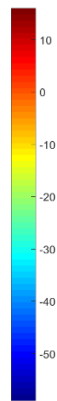
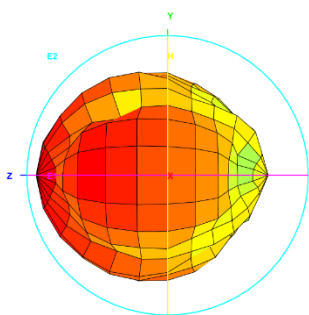

Total_3D_Side View 1_2.4GHz

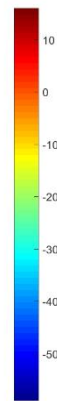
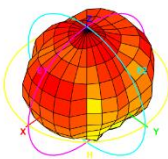

Total_3D_Top View_2.6GHz

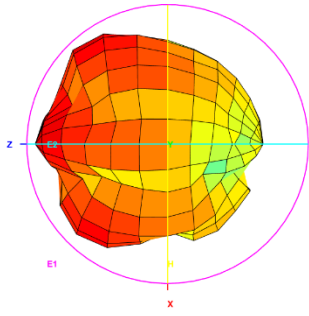

Total_3D_Front View_2.6GHz

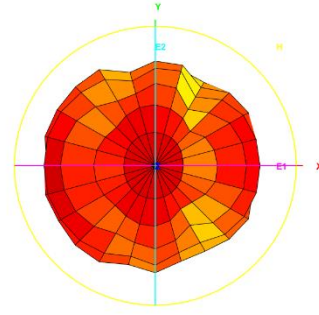

Total_3D_Left View_2.6GHz

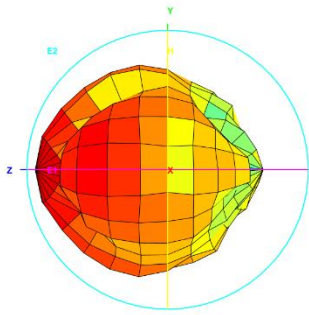

Total_3D_Side View 1_2.6GHz

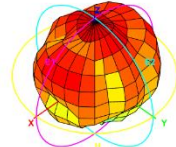

Total_3D_Top View_2.7GHz

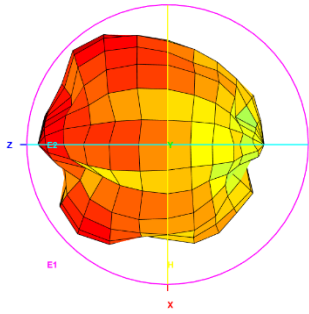

Total_3D_Front View_2.7GHz

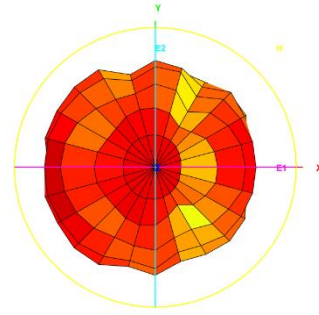

Total_3D_Left View_2.7GHz

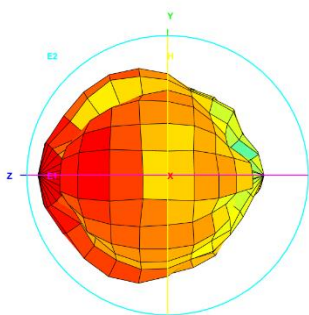

Total_3D_Side View 1_2.7GHz

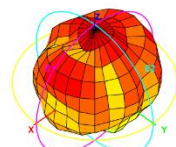

Total_3D_Top View_3.3GHz

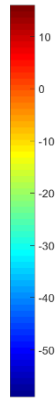
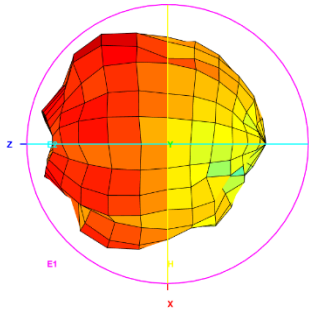

Total_3D_Front View_3.3GHz

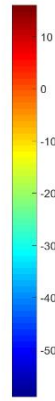
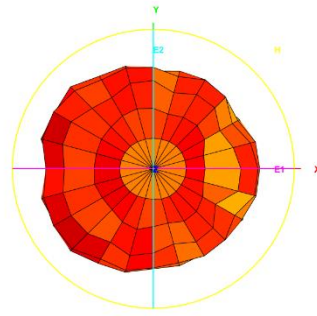

Total_3D_Left View_3.3GHz

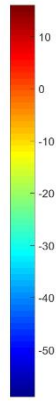
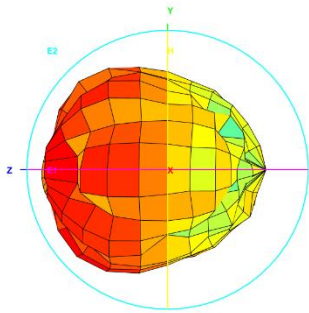

Total_3D_Side View 1_3.3GHz

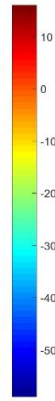
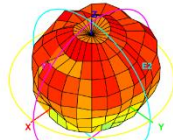

Total_3D_Top View_3.4GHz

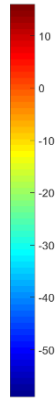
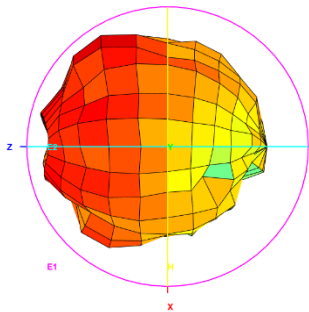

Total_3D_Front View_3.4GHz

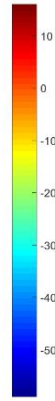
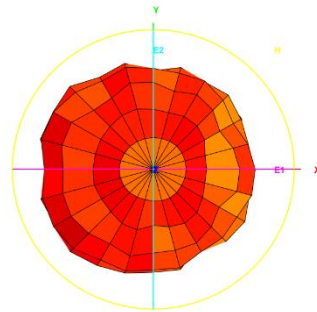

Total_3D_Left View_3.4GHz

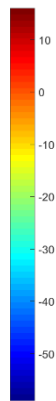
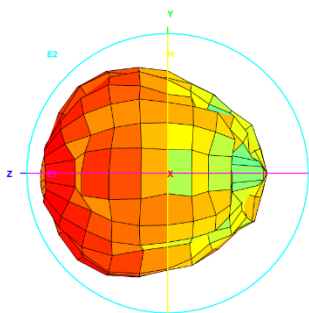

Total_3D_Side View 1_3.4GHz

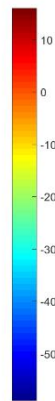
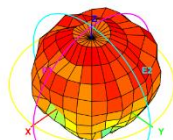

Total_3D_Top View_3.6GHz

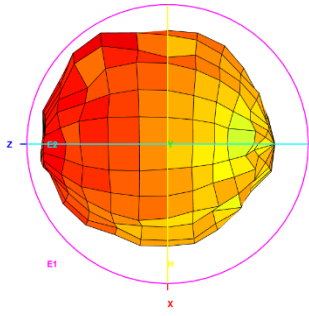

Total_3D_Front View_3.6GHz

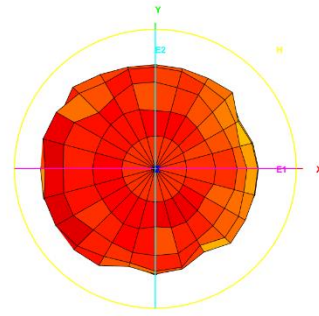

Total_3D_Left View_3.6GHz

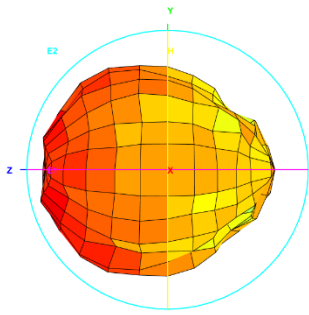

Total_3D_Side View 1_3.6GHz

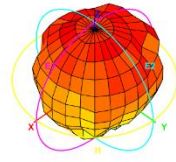

Total_3D_Top View_3.8GHz

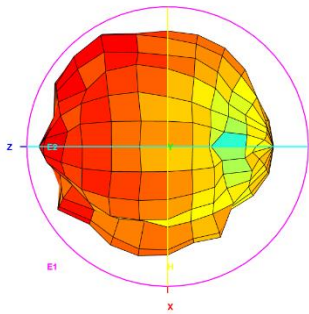

Total_3D_Front View_3.8GHz

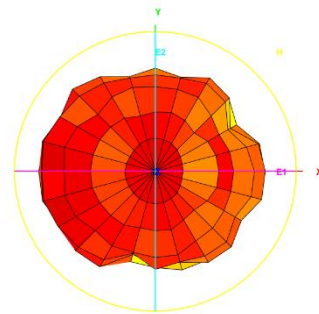

Total_3D_Left View_3.8GHz

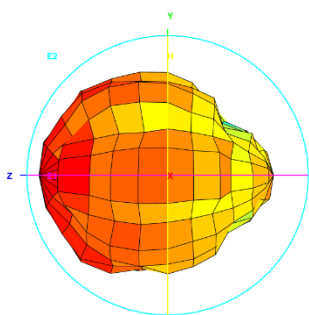

Total_3D_Side View 1_3.8GHz

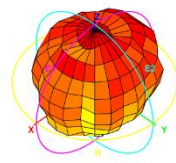

Total_3D_Top View_4.4GHz

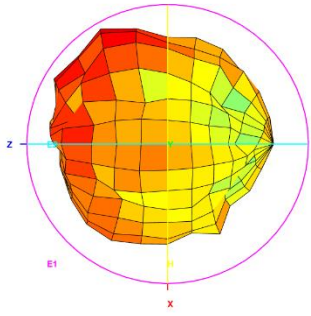

Total_3D_Front View_4.4GHz

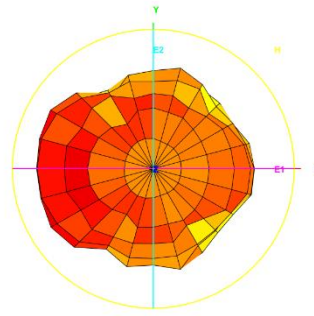

Total_3D_Left View_4.4GHz

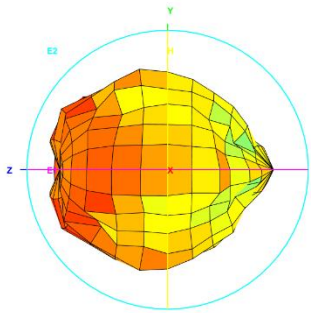

Total_3D_Side View 1_4.4GHz

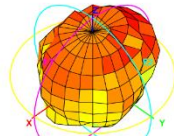

Total_3D_Top View_5.1GHz

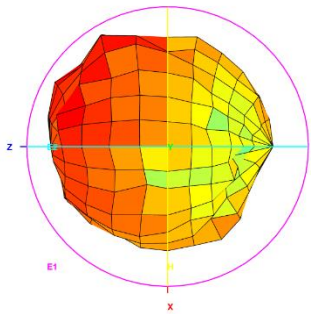

Total_3D_Front View_5.1GHz

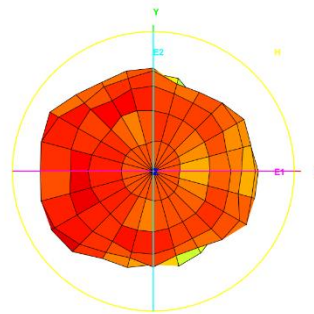

Total_3D_Left View_5.1GHz

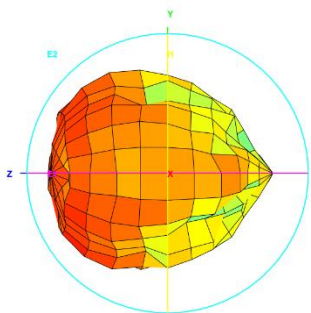

Total_3D_Side View 1_5.1GHz

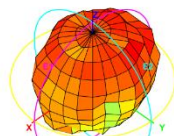

Total_3D_Top View_5.5GHz

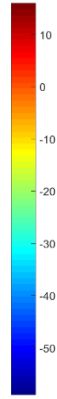
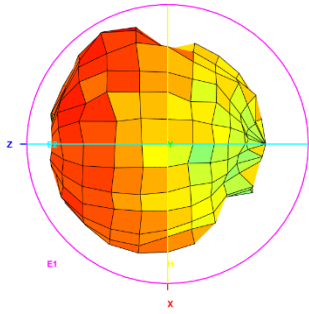

Total_3D_Front View_5.5GHz

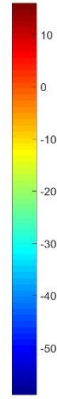
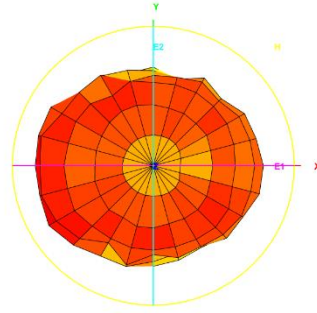

Total_3D_Left View_5.5GHz

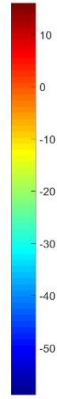
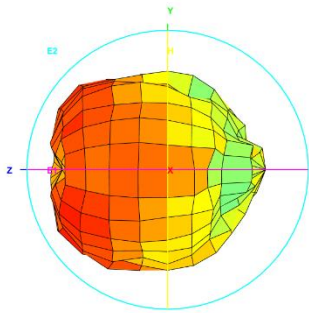

Total_3D_Side View 1_5.5GHz

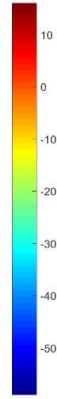
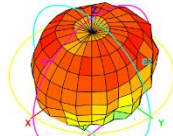

Total_3D_Top View_5.8GHz

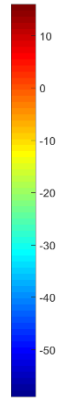
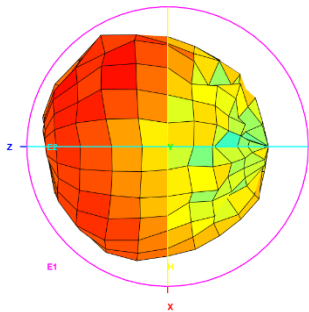

Total_3D_Front View_5.8GHz

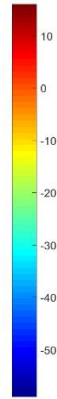
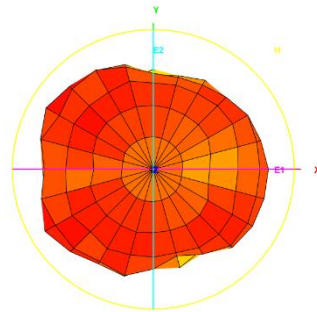

Total_3D_Left View_5.8GHz

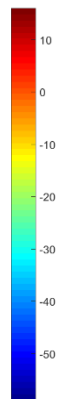
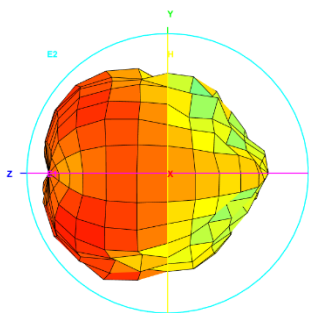

Total_3D_Side View 1_5.8GHz

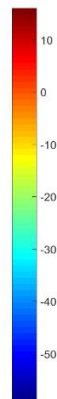
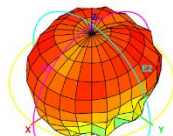

Total_3D_Top View_5.95GHz

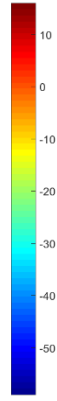
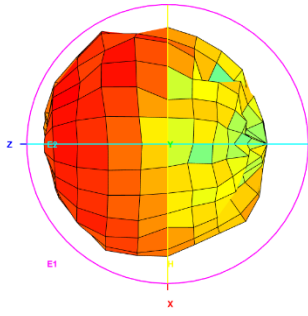

Total_3D_Front View_5.95GHz

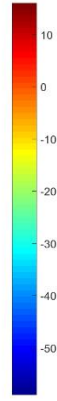
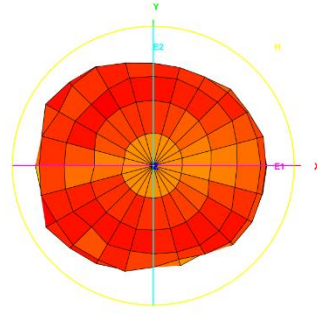

Total_3D_Left View_5.95GHz

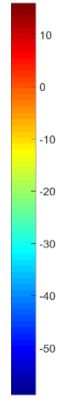
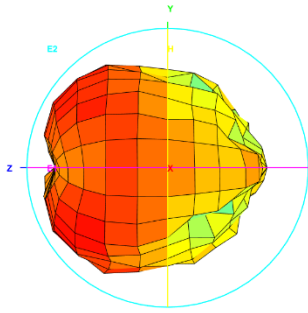

Total_3D_Side View 1_5.95GHz

